



**Murdoch**  
UNIVERSITY

**MURDOCH RESEARCH REPOSITORY**

<http://researchrepository.murdoch.edu.au/11391/>

Gyamfi, S., Krumdieck, S. and Brackney, L. (2010) Pattern recognition residential demand response: An option for critical peak demand reduction. In: 4th International Conference on Sustainability Engineering and Science, 30 November - 3 December 2010, Auckland, New Zealand.

It is posted here for your personal use. No further distribution is permitted.

**AUTHOR:** Samuel Gyamfi, B.Sc. Eng(KNUST), M.Sc. Energy(Aachen)

**Co-authors:** Susan Krumdieck, Assoc Prof., BS, MS(Ariz. State),PhD(Colorado),  
MRSNZ

Larry Brackney, Building Systems Engineer, NREL, USA.  
BSME(RHIT), MS(RHIT), PhD(Purd.)

**Title:** Pattern Recognition Residential Demand Response: An Option for  
Critical Peak Demand Reduction in New Zealand

Contact information

Advanced Energy and Material Systems Laboratory, Department of Mechanical Engineering,  
University of Canterbury, Private Bag 4800, Christchurch, New Zealand Telephone: +64 3364 2987  
Ext: 4107, Fax: +64 3364 2078 Email: Samuel.gyamfi @pg.canterbury.ac.nz or  
gyamfisamuel@gmail.com

### **Abstract**

Influencing households to adopt sustainable energy consumption behaviour is important to the transition towards a sustainable energy future. However, if one aims at influencing the energy consumption habits of people, one should also be able to estimate the resulting effects on the entire energy system. Residential demand response to reduce load on the electricity network has largely been impeded by information barriers and a lack of proper understanding of consumers' behaviour. What are not well understood and are of great interest include load disaggregation, the behaviour of customers when responding to demand response request, load shifting models and their impact on the load curve of the utility. There is concern among demand response practitioners, for example, that demand response in the residential sector may simply move the peak problem with scale from one point in time to another. However, unavailability of appliance-level demand data makes it difficult to study this problem.

In this paper, a generalized statistical model for generating load curves of the individual residential appliances is presented. These data allow one to identify the relative contribution of the different components of the residential load on a given residential feeder. This model has been combined with demand response survey in a neighbourhood with 400 households in Christchurch, New Zealand, to determine the effect of customers' behaviour in reducing the neighbourhood's winter peak demand. The results show that when customers' are given enhanced information, they would voluntarily act to reduce their peak demand by about 10% during the morning peak hours and 11% during the evening peak hours. The demand responsiveness of the individual appliances is also presented. The effectiveness of customer behaviour modification in maintaining system reliability is also presented.

Keywords: Demand Response, Modelling, Residential Sector, Human Behaviour

## 1. Introduction

Demand response is defined broadly as “changes in electricity usage by the end-use customers from their normal consumption pattern in response to changes in price of electricity over time, or to incentive payment designed to induce lower electricity use at times of high wholesale market price or when system reliability is jeopardized” [USDOE, 2006]. Demand response resource is simple the magnitude of load reduction that occur when demand response signal is given. One of the main objectives of demand response analysis is to determine this resource during demand response event for the purpose of the event analysis and program evaluation. Two key measurement components are essential to the determination of demand response resource.

- **Baseline** – the consumption or demand that would have occurred, if the demand response had not taken place.
- **Responsive Load** – the observed consumption or demand that occurs when the demand response signal is given and the anticipated participation is achieved.

Since the responsive load during demand response event is usually known, the key challenge is how to accurately estimate the baseline. If the baseline and responsive load could be modelled, then demand response resource would simply be the mathematical difference between the baseline and the responsive load, as illustrated in figure 1.

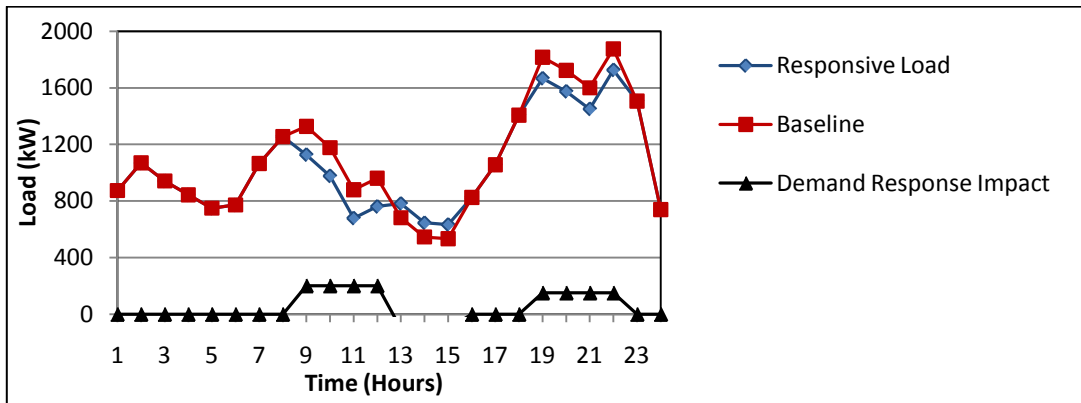

Figure 1: An illustration of demand response resource estimation problem

The demand response resources is usually estimated at an aggregate. In the residential sector, a better understanding of the customer behaviour or the usage behaviour of the different components of the residential load may also be required. One of the main barriers to residential demand response is the lack of proper understanding of residential customers’ behaviour in responding to demand response requests [DRRC, 2007]. There is a concern among demand response practitioners that demand response in the residential sector may simply move the peak problem with scale from one point in time to another. Load disaggregation or the behaviour of the different components of the residential load will be required to study this problem, especially the effect of load shifting models on the aggregate load. However, unavailability of appliance-level load data makes it difficult to study this problem. In the following sections, a generalized model to generate the load curve from the individual components of the residential load is presented. These data allow one to identify the relative contribution

of the different components of the residential load to the sector's peak demand and the effectiveness of the individual households' appliances in reducing the peak load on the electricity network.

## **2. Development of a Generic Appliance-based Load Curve**

The appliance-load curve model is a “bottom–up” approach of generating the aggregate load profile of residential customers in which the pattern of usage of individual appliances are represented. The bottom-up approach has been used, for example, in the load model by Capasso et al. [Capasso, 1994], where probability functions representing the relationship between the demand of a residential customer and the psychological and behavioural factors typical of households were established through the use of a Monte Carlo method. Estimating these relationships at the individual household level makes the Capasso et al. model highly complex because these factors are extremely subjective and not easily defined with any certainty at that level.

In this study, the load curves of the major household appliances whose aggregate defines the load profile of residential customers were generated using the method of diversified demand. This method was developed by Arvidson in 1940 [Gönen, 2008] to estimate the load on distribution transformers when measurements of the actual load are limited. The diversified demand method has seen increased interest in recent times due to the revived interest in residential demand response and the need for component by component analysis of residential load. The method is straightforward and makes use of standard behaviour of the various types of household appliances as applied to a group of residential customers through use of statistical correlations. According to the diversified demand method, if a location can in aggregate be considered statistically representative of the residential customers as a whole, a load curve for the entire residential class of customers can be prepared. If the same technique is used for other classes of customers, similar load curves can be prepared [Gönen, 2008]. The construction of the appliance load curve requires certain load information to be available. Load saturation and load diversity data are needed for the class of customers whose load curve is to be generated. The diversified demand takes into account the fact that households may not be using all the electrical appliances that constitute the connected load of the house at the same time or to their full capacity. The load curve is constructed from the most probable load – the load that creates demand on the distribution facility.

### *Definition of Terms*

The following terms relating to the power supply and demand are worth defining before the method of diversified demand is introduced.

*Diversified demand* – the demand of the composite group, as a whole, of somewhat unrelated loads over a specified period of time [Gönen, 2008]. It describes the variation in the time of use (or the maximum use) of two or more loads.

*Maximum diversified demand* – the maximum sum of the contribution of the individual demand to the diversified demand over a specific time interval.

*Connected load* – the sum of the continuous ratings of load-consuming apparatus connected to the system.

*Feeder* – the circuit which carries a large block of power from the service equipment to some points at which it is broken into smaller circuits.

*Residential feeder*- a feeder that serves only residential customers i.e. households

*Distribution transformer* – the device use to converts electrical energy of higher voltage to a lower voltage, with frequency identical before and after the transformation.

*Hourly variation factor* – the ratio of demand of a particular type of load co-incident with the group maximum demand to the maximum demand of that particular type of load [Gönen, 2008]. It is simply the percentage of appliance load that coincides with the group maximum load.

*Appliance saturation rate* – the saturation rate of an appliance category is defined as the percentage of households that own at least one of a given appliance.

### 3. Modelling Approach

Figure 2 illustrates the approach used to estimate the load curves of the individual household appliances.  $F_1, F_2, F_3$  and  $F_4$  represent typical residential feeders.  $H_1, H_2 \dots H_m$  are houses on a distribution transformer which are fed by the feeder  $F_4$ .  $A_1, A_2 \dots A_n$  represent the different household appliances. The average maximum diversified demand of the appliance categories for a group of customers is calculated from equation 1.

$$MDD_{(av, max)i} = MDD_i * n_i \quad (1)$$

$$n_i = m * s_i \quad (2)$$

$MDD_{(av, max)i}$  is the average maximum diversified demand of an appliance category for a group of customers,  $MDD_i$  is the maximum diversified demand of an appliance per customer.  $n_i$  is the number of appliance of that category,  $m$  represents the total number of households under consideration, and  $s_i$  represents the saturation rate of the appliance category.  $MDD$  depends on the total number of appliance  $n$ . The  $MDD$  corresponding to different  $n$  for some household appliances is presented in table 1 [Gönen, 2008]. As the number of appliances ( $n$ ) increases the maximum diversified demand per customer ( $MDD_i$ ) decreases until it becomes a constant at large  $n$  values. The hourly maximum diversified demand,  $MDD_{(t, max)i}$  is calculated from equation 3.

$$MDD_{(t, max)i} = MDD_i * n_i * f_i(t) \quad (3)$$

$f_i(t)$  is the hourly variation factors of the appliance categories.  $f_i(t)$  depend on the living habits of the individuals in a particular area and may differ from location to location. These factors define the pattern of the load curves. The maximum load on the distribution transformer at any time is given by the sum of the maximum diversified demand of the individual appliances and is determined from equation 4.

$$MLT_{(t, max)} = \sum_{i=1}^N MDD_{(t, max)i} = \sum_{i=1}^N MDD_i * n_i * f_i(t) \quad (4)$$

Where  $MLT_{(t, max)}$  is the maximum load on the distribution transformer at any hour of the day, and  $N$  is number of appliance categories ( i.e. washing machine, heat pump, clothes dryer, etc.).

### 4. Case Study in Christchurch, New Zealand

The generic household appliance load curve methodology described above was applied in a case study in Halswell, a small neighbourhood in Christchurch, New Zealand, with approximately 400 households. The Halswell neighbourhood was selected as a location for the case study due to its unique nature as the only area in

Christchurch which has its own residential feeder. There are no retail, commercial or industrial load on this feeder. It was selected to make it possible to compare the modelling results with the actual load measured by the utility.

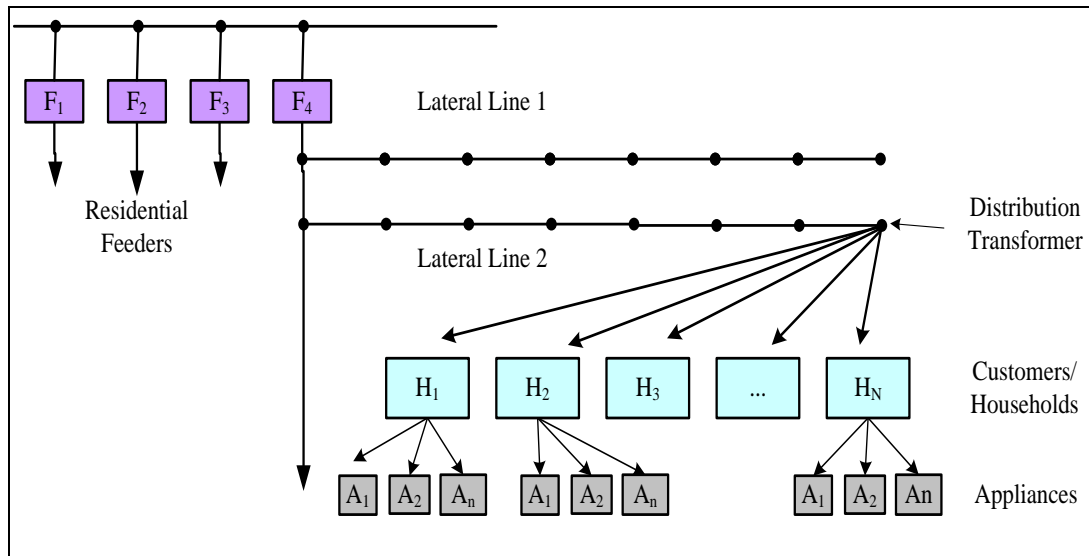

Figure 2: Illustration of the modelling approach for a group of customers

Table 1: Maximum 30 minutes average diversified demand per customers (kW) for given number ( $n$ ) of appliance [Gönen, 2008].

Appliances	n=1	n=5	n=10	n=20	n=40	n=80	n=100
Direct Water Heater	1.1	0.37	0.22	0.18	0.14	0.1	0.1
Heat Pump	4.50	3.00	3.00	2.80	2.80	2.80	2.80
Electric Heater	7.00	4.00	3.50	3.20	3.20	3.20	3.20
Cloth Dryer	4.30	1.80	1.50	1.20	1.00	1.00	1.00
Home Freezer	0.30	0.13	0.10	0.08	0.08	0.08	0.08
Refrigerator	0.18	0.07	0.06	0.05	0.05	0.05	0.05
Range	2.30	0.90	0.70	0.60	0.50	0.50	0.50
Lighting & Misc.	1.10	0.65	0.60	0.55	0.52	0.52	0.52

The total number of each appliance category ( $n_i$ ) was determined by multiplying the total number of households ( $m = 400$  in this case) by the appliance saturation rates ( $s_i$ ). The appliance saturation rates for New Zealand [Electricity-Commission, 2007] were used for the location. The saturation rate of heat pumps was taken from a recent BRANZ study [French, 2008]. The saturation rate of electric heaters was adjusted to reflect the situation at the Halswell area. Halswell is a relatively new suburb in Christchurch with high penetration of heat pumps. The saturation rate of electric heater is expected to be lower than the New Zealand average as space heating is done mainly with heat pumps. Table 2 Shows the average maximum diversified demand estimated for 400 households in Halswell, neighbourhood in Christchurch.

*Estimation of the hourly variation factor,  $f_i(t)$*

The hourly variation factors,  $f_i(t)$  reveal the behaviour characteristics of appliance usage and depends on the living habits of the individuals in a particular location. These living habits in turn are affected by the socio-economic factors such as the number of occupants in the individual households, their age and income. The hourly

variation factors for New Zealand were estimated from the results of the first two years report of New Zealand Household Energy End-Use Project (HEEP) [Stoeklein, 1998], and data from Orion Networks, the distribution company in the Christchurch area. The HEEP study measured interval electricity demand of household appliances in winter in some regions in New Zealand. The data from the HEEP pattern of usage and the information from Orion Network were used to estimate the hourly variation factors shown in figure 3. Figure 4 shows the hourly maximum diversified demand or the load profile estimated for the 400 households on the Halswell residential feeder compared with the actual profile measured by the utility in some selected days in winter 2006.

Table 2: The average maximum diversified demand calculated for 400 households.

Appliances	Appliance saturation rate (%)	Total number of appliance	Diversified demand per customer (kW)	Maximum diversified demand (kW)
Domestic Water Heater	87	348.00	0.72	250.56
Heat Pump*	35	140.00	2.60	364.00
Electric Heater**	93	372.00	3.00	1116.00
Clothes Dryer	34	136.00	1.20	163.20
Washing Machine	95	380.00	1.20	456.00
Freezer	64	256.00	0.08	20.48
Refrigerator	31	124.00	0.06	6.82
Fridge/Freezer	80	320.00	0.08	25.60
Microwave/Oven	78	312.00	0.50	156.00
Range	93	372.00	0.55	204.60
Lighting & Misc.	100	400.00	0.54	216.00

The appliance saturation rates were all taken from the a recent study by the electricity commission [Electricity-Commission, 2007] except \* which was taken from recent BRANZ heat pump study [French, 2008]. \*\* Saturation of electric heater has been adjusted to reflect the situation as Halswell.

## 5. Activity Demand Response in Halswell

In order to calculate the demand response resource of the Halswell neighbourhood, the households' willingness to adjust their demand in a hypothetical supply constraint situation in winter obtained through survey in the area was combined with the appliance load data obtained through modelling (see table 3). The magnitude of the customers' Activity Demand Response (ADR) was calculated from equation 5. The activity demand response of a customer group is defined here as the magnitude of load reduction obtained as a result of customers adjusting the usage of a given household appliance.

$$ADR_{i(t)} = MDDi(t) * dx_i \quad (5)$$

Where  $ADR_{i(t)}$  represents customer activity demand response, and  $dx_i$  is the likelihood that an appliance would be offered to participate in demand response.  $dx_i$  was obtained by multiplying the probability that an appliance would be used during the peak hours by the likelihood that the usage of that same appliance would be adjusted in response to critical supply constraint at peak demand hours. The survey results are presented in table 3.

The average activity demand response for the Halswell neighbourhood is shown in figure 5. The average activity demand response during the morning (07 – 08) peak

hours ranges from 2 kW for clothes dryer, representing just over 0.1% of the average morning peak load to as high as 50 kW for electric heater, representing 3.4% of the morning peak load. The highest activity demand response during the evening peak hours (18:00 – 19:00) was 97 kW obtained from heat pump, followed by 32.6 kW from washing machine, and 32.5 kW from electric heater. The average activity peak demand response was higher during the evening peak hours at 188.4 kW, representing 11% of the evening peak load, than 144 kW of the morning peak reduction, representing nearly 10% of the morning peak load. Table 4 shows the detail activity demand response during the peak hours.

Figure 3: Hourly variation Factors determined for winter in New Zealand

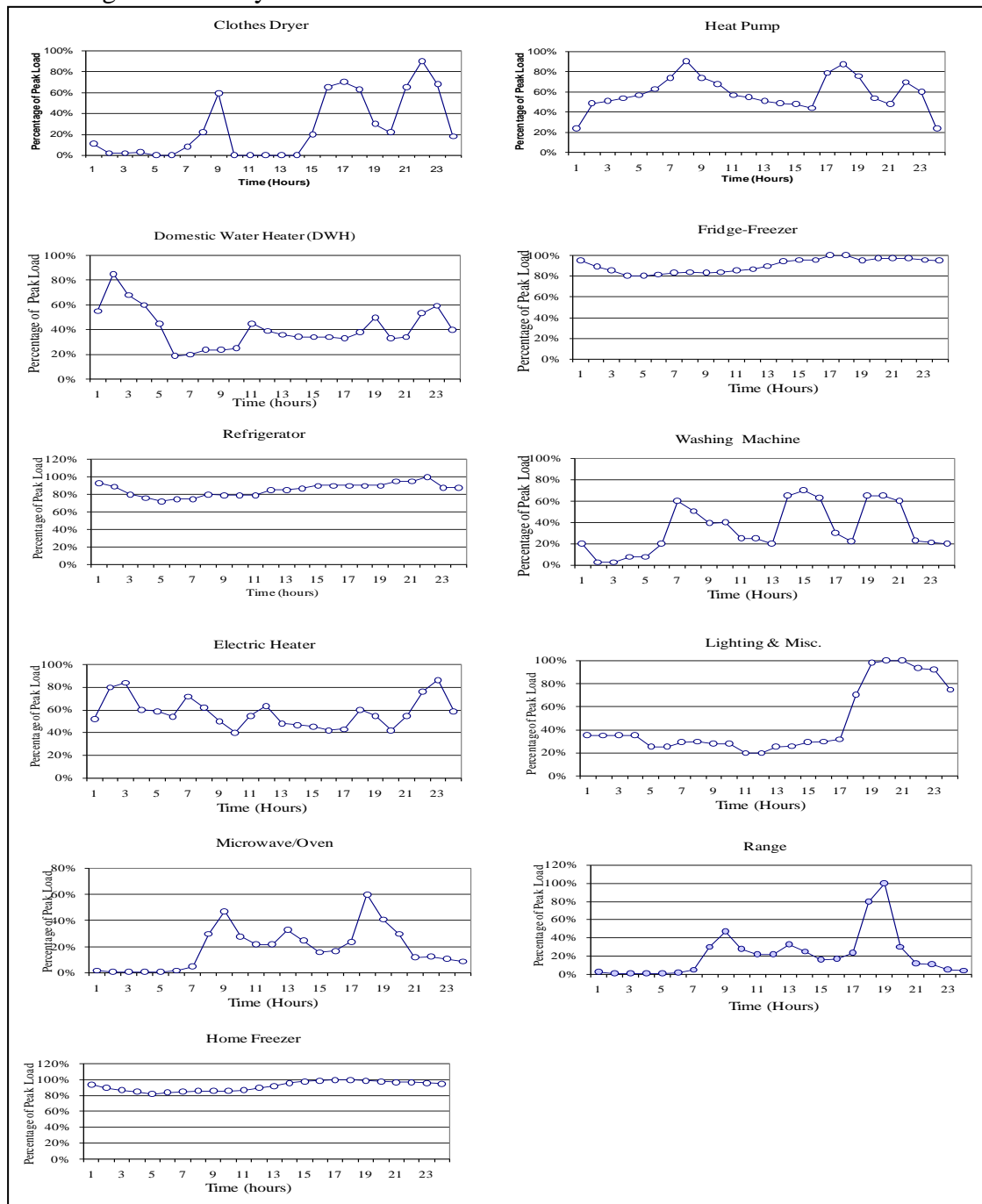



Figure 4: Estimated load curve for the 400 households in Halswell compared with the measured load by the utility in winter, 2006.

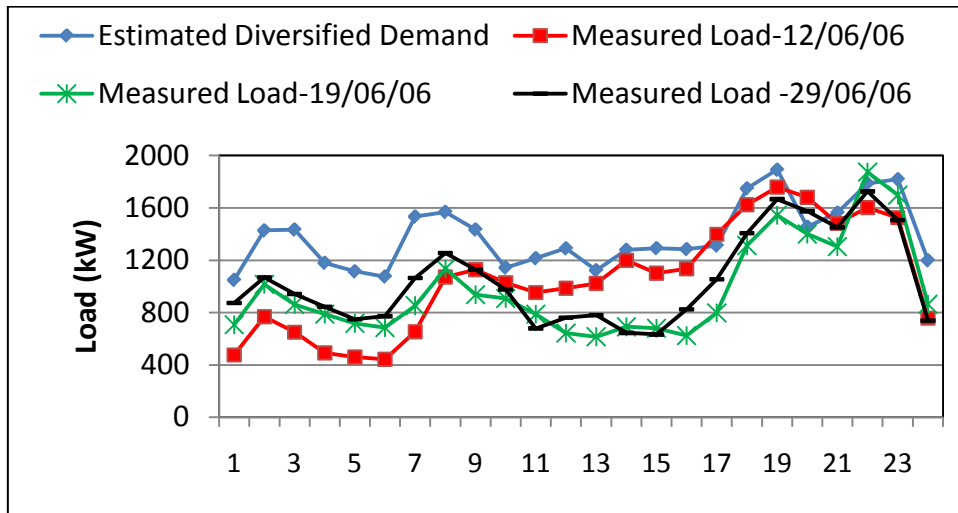

Table 3: Likelihood of household appliance usage at the peak times and the corresponding demand response participation.

Appliances	Likelihood of Peak Usage (%)		Likelihood of Demand Response Participation (%)		Achievable Household Demand Response Participation (%)	
	Morning	Evening	Morning	Evening	Morning	Evening
Cloth Dryer	8	12	33	33	3	5
Computer	15	36	42	46	8	21
Dishwasher	12	31	37	36	6	14
Electric Kettle	65	61	13	19	10	15
Hair Dryer	46	4	31	35	18	2
Heat Pump	46	59	26	19	15	14
Heated Towel Rail	32	26	41	42	16	13
Microwave	44	49	22	17	12	10
Electric Heaters	21	18	33	28	8	6
Oven	9	47	49	40	6	23
Range	12	47	42	24	6	14
Spa Pool	2	4	15	15	0	1
Stereo	10	6	33	33	4	3
TV	16	70	32	19	6	17
Vacuum Cleaner	17	12	35	35	7	5
Washing Machine	33	21	42	42	17	11

In a further analysis, the modelling result above was compared with domestic water heating load that are ripple-controlled by the distribution company in the Halswell area during critical evening peak hours. The result of this comparison is shown in figure 6. The customer activity demand response was higher than the domestic hot water heating load that is ripple-controlled during the evening peak hours indicating the potential of voluntary customer demand response to maintain system reliability.

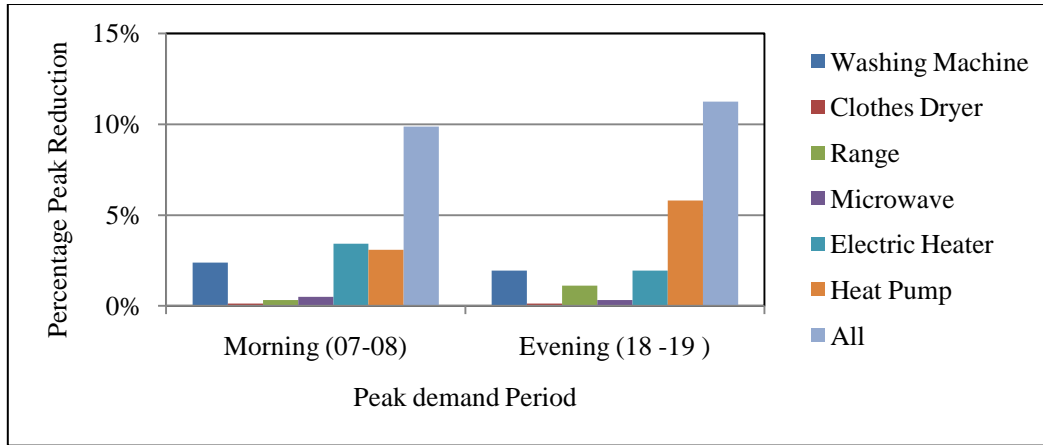

Figure 5: Average activity demand response for 400 households at the morning and the evening peak hours.

Table 4: Peak demand response (kW) for 400 households in Halswell, Christchurch.

Peak Time	Washing Machine	Clothes Dryer	Range	Microwave	Electric Heater	Heat Pump	All
7.00	39.5	1.1	3.7	5.6	55.4	49.7	155.0
8.00	30.2	2.9	5.8	8.8	44.6	40.4	132.7
Morning Average	34.9	2.0	4.7	7.2	50.0	45.0	143.8
% of Morning Peak	2.4%	0.1%	0.3%	0.5%	3.4%	3.1%	9.9%
18.00	32.6	2.4	28.6	6.4	36.8	113.4	220.3
19.00	32.6	1.8	8.6	4.7	28.1	80.6	156.4
Evening Average	32.6	2.1	18.6	5.5	32.5	97.0	188.4
% of Evening Peak	1.9%	0.1%	1.1%	0.3%	1.9%	5.8%	11.2%

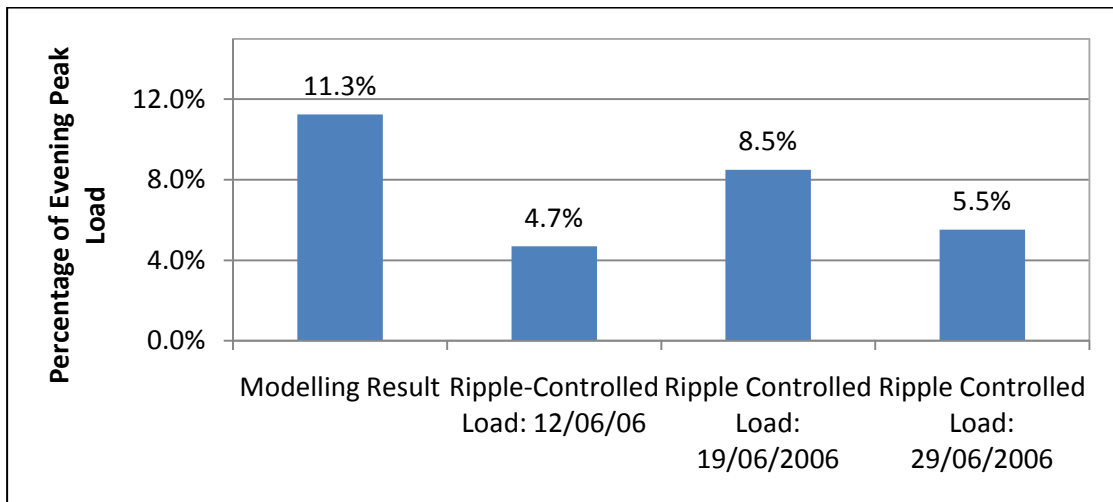

Figure 6: Comparison of the modelling results and ripple-controlled domestic water heating load during the evening peak hours in some selected days in winter 2006.

### *Demand Response in Christchurch*

In order to calculate the potential of the activity demand response in Christchurch, the peak demand reduction obtained for the 400 households in Halswell was projected onto the total number households in the Christchurch city (approximately 131,833 households). The resulting load curve after activity demand response redistribution was compared with the measured load on the entire Orion's Distribution Network on the 19<sup>th</sup> of June 2006. Note that the:

- Measured load is a controlled load, as the Orion network had a capacity limit of about 600 MW in 2006, and the peak load is controlled to remain below this limit.
- Load on the entire network has all customers (industrial, commercial and residential).

It was shown that the average morning peak load could be reduced with the voluntary activity demand response by 44 MW, representing 7.3% of the morning peak load on the entire Orion's network, while the evening peak load could be reduced by 57.00 MW, representing 9.3%. Figure 8 shows the reduction in peak load if the results obtained for the Halswell neighbourhood is projected onto the total number of households in Christchurch. This result is based on the assumption that all the households in Christchurch will behave the same way as the customers in the Halswell neighbourhood. Indeed a random demand response of households in Christchurch gave results similar to that of the Halswell neighbourhood.

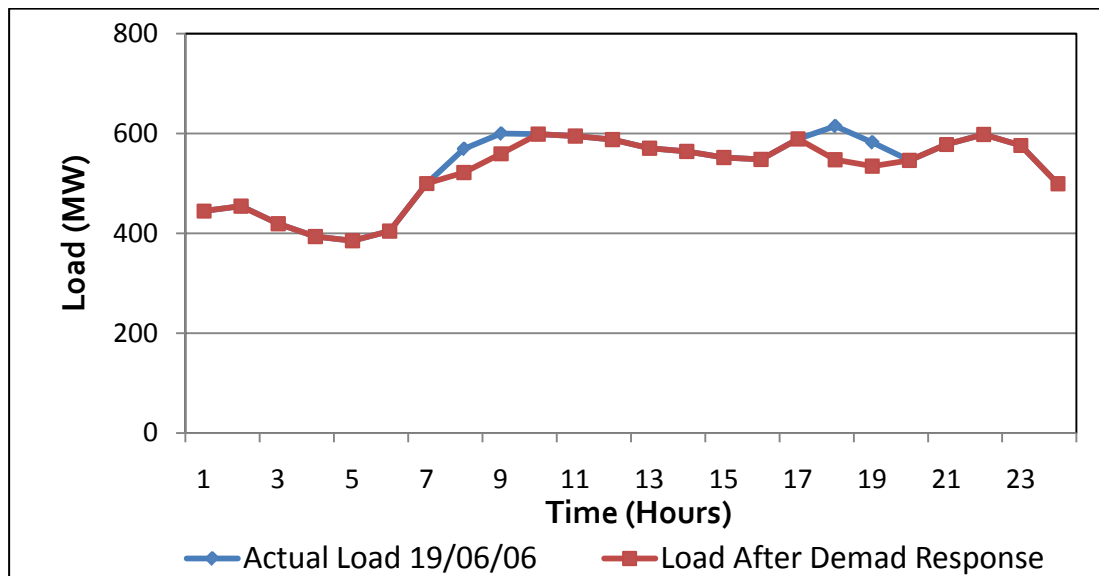

Figure 7: Impact of voluntary activity demand response on the entire Orion's Networks

## **6. Conclusions**

This paper reports a generic methodology for generating load curves of the individual components (appliances) that make up the aggregate load on a typical residential feeder and estimate the impact of appliance demand response on the load curve of the utility. The results of the survey conducted in Christchurch about customers' willingness to adjust their demand in a critical peak demand periods were used as input into the model together with appliance saturation and load diversity to estimate

the voluntary activity demand response on a typical residential feeder. The results show that nearly 10% reduction in the morning peak load could be achieved. The evening peak load could be reduced by just over 11%. It is quite interesting to note that this voluntary activity demand response is comparable to the water heating load that is usually rippled controlled by the electricity distribution company in Halswell in order to maintain system reliability. This suggests that, when customers are given information and encouragement they would voluntarily act to reduce their demand to ensure system reliability.

## 7. References

- CAPASSO, A., GRATTIERI, W., LAMEDICA, R., PRUDENZI, A. (1994) A Bottom-up Approach to Residential Load Modelling *IEEE Transactions on Power Systems*, Vol. 9, :No. 2.
- DRRC (2007) Understanding Customer Behaviour to Improve Demand Response Delivery in California *PIER Demand Response Research Centre Research Opportunity Notice DRRC RON -3*
- ELECTRICITY-COMMISSION (2007) New Zealand Efficiency Potential Study Vol. 1 Electricity *Commission Wellington, New Zealand*
- FRENCH, L. (2008) Active Cooling and Heat Pump Use in New Zealand. *Study Report No. 186, BRANZ, Wellington*
- GÖNEN, T. (2008) Electric Power Distribution System Engineering. 2nd edition *Taylor & Francis Group*.
- STOEKLEIN, A., POLLARD, A., ISAACS, N., BISHOP, S., JAMES, B., RYAN, G., SANDERS, I. (1998) Energy End-Use And Socio/Demographic Occupant Characteristics of New Zealand Households *BRANZ New Zealand Publication*.
- USDOE (2006) Benefits of Demand Response in Electricity Markets and Recommendations for achieving them *Report to the United State Congress Pursuant to the Section 1252 of the Energy Policy Act of 2005, DOE, U.S.*